

NTHS5441

Power MOSFET

-20 V, -5.3 A, P-Channel ChipFET™

Features

- Low $R_{DS(on)}$
- Higher Efficiency Extending Battery Life
- Logic Level Gate Drive
- Miniature ChipFET Surface Mount Package
- Pb-Free Package is Available

Applications

- Power Management in Portable and Battery-Powered Products; i.e., Cellular and Cordless Telephones and PCMCIA Cards

MAXIMUM RATINGS ($T_A = 25^\circ\text{C}$ unless otherwise noted)

Rating	Symbol	5 sec	Steady State	Unit
Drain-Source Voltage	V_{DS}	-20		V
Gate-Source Voltage	V_{GS}	± 12		V
Continuous Drain Current ($T_J = 150^\circ\text{C}$) (Note 1) $T_A = 25^\circ\text{C}$ $T_A = 85^\circ\text{C}$	I_D	-5.3 -3.8	-3.9 -2.8	A
Pulsed Drain Current	I_{DM}	± 20		A
Continuous Source Current (Note 1)	I_S	-5.3	-3.9	A
Maximum Power Dissipation (Note 1) $T_A = 25^\circ\text{C}$ $T_A = 85^\circ\text{C}$	P_D	2.5 1.3	1.3 0.7	W
Operating Junction and Storage Temperature Range	T_J, T_{stg}	-55 to +150		$^\circ\text{C}$

Maximum ratings are those values beyond which device damage can occur. Maximum ratings applied to the device are individual stress limit values (not normal operating conditions) and are not valid simultaneously. If these limits are exceeded, device functional operation is not implied, damage may occur and reliability may be affected.

1. Surface Mounted on FR4 Board using 1 in sq pad size (Cu area = 1.27 in sq [1 oz] including traces).



ON Semiconductor®

<http://onsemi.com>

$V_{(BR)DSS}$	$R_{DS(on)}$ TYP	I_D MAX
-20 V	46 m Ω @ -4.5 V	-5.3 A

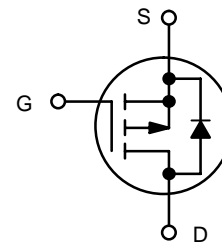

P-Channel MOSFET

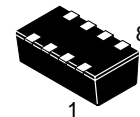

ChipFET
CASE 1206A
STYLE 1

PIN CONNECTIONS

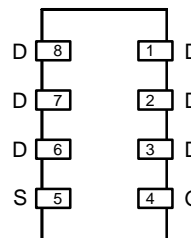

MARKING DIAGRAM

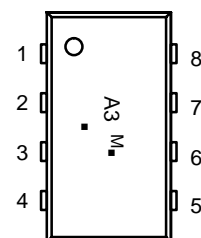

A3 = Specific Device Code

M = Month Code

▪ = Pb-Free Package

(Note: Microdot may be in either location)

ORDERING INFORMATION

Device	Package	Shipping†
NTHS5441T1	ChipFET	3000/Tape & Reel
NTHS5441T1G	ChipFET (Pb-Free)	3000/Tape & Reel

†For information on tape and reel specifications, including part orientation and tape sizes, please refer to our Tape and Reel Packaging Specifications Brochure, BRD8011/D.

NTHS5441

THERMAL CHARACTERISTICS

Characteristic	Symbol	Typ	Max	Unit
Maximum Junction-to-Ambient (Note 2) $t \leq 5$ sec Steady State	$R_{\theta JA}$	40 80	50 95	$^{\circ}\text{C/W}$
Maximum Junction-to-Foot (Drain) Steady State	$R_{\theta JF}$	15	20	$^{\circ}\text{C/W}$

ELECTRICAL CHARACTERISTICS ($T_J = 25^{\circ}\text{C}$ unless otherwise noted)

Characteristic	Symbol	Test Condition	Min	Typ	Max	Unit
Static						
Gate Threshold Voltage	$V_{GS(th)}$	$V_{DS} = V_{GS}, I_D = -250 \mu\text{A}$	-0.6		-1.2	V
Gate-Body Leakage	I_{GSS}	$V_{DS} = 0 \text{ V}, V_{GS} = \pm 12 \text{ V}$			± 100	nA
Zero Gate Voltage Drain Current	I_{DSS}	$V_{DS} = -16 \text{ V}, V_{GS} = 0 \text{ V}$			-1.0	μA
		$V_{DS} = -16 \text{ V}, V_{GS} = 0 \text{ V}, T_J = 85^{\circ}\text{C}$			-5.0	
On-State Drain Current (Note 3)	$I_{D(on)}$	$V_{DS} \leq -5.0 \text{ V}, V_{GS} = -4.5 \text{ V}$	-20			A
Drain-Source On-State Resistance (Note 3)	$r_{DS(on)}$	$V_{GS} = -3.6 \text{ V}, I_D = -3.7 \text{ A}$ $V_{GS} = -4.5 \text{ V}, I_D = -3.9 \text{ A}$	-	0.050 0.046	0.06 -	Ω
		$V_{GS} = -2.5 \text{ V}, I_D = -3.1 \text{ A}$		0.070	0.083	
Forward Transconductance (Note 3)	g_{fs}	$V_{DS} = -10 \text{ V}, I_D = -3.9 \text{ A}$		12		mhos
Diode Forward Voltage (Note 3)	V_{SD}	$I_S = -2.1 \text{ A}, V_{GS} = 0 \text{ V}$		-0.8	-1.2	V

Dynamic (Note 4)

Total Gate Charge	Q_G	$V_{DS} = -10 \text{ V}, V_{GS} = -4.5 \text{ V}, I_D = -3.9 \text{ A}$		9.7	22	nC
Gate-Source Charge	Q_{GS}			1.2		
Gate-Drain Charge	Q_{GD}			3.6		
Input Capacitance	C_{iss}	$V_{DS} = -5.0 \text{ Vdc}, V_{GS} = 0 \text{ Vdc}, f = 1.0 \text{ MHz}$		710		μF
Output Capacitance	C_{oss}			400		
Reverse Transfer Capacitance	C_{rss}			140		
Turn-On Delay Time	$t_{d(on)}$	$V_{DD} = -10 \text{ V}, R_L = 10 \Omega, I_D \cong -1.0 \text{ A}, V_{GEN} = -4.5 \text{ V}, R_G = 6 \Omega$		14	30	ns
Rise Time	t_r			22	55	
Turn-Off Delay Time	$t_{d(off)}$			42	100	
Fall Time	t_f			35	70	
Source-Drain Reverse Recovery Time	t_{rr}	$I_F = -1.1 \text{ A}, di/dt = 100 \text{ A}/\mu\text{s}$		30	60	

2. Surface Mounted on FR4 Board using 1 in sq pad size (Cu area = 1.27 in sq [1 oz] including traces).

3. Pulse Test: Pulse Width $\leq 300 \mu\text{s}$, Duty Cycle $\leq 2\%$.

4. Guaranteed by design, not subject to production testing.

TYPICAL ELECTRICAL CHARACTERISTICS

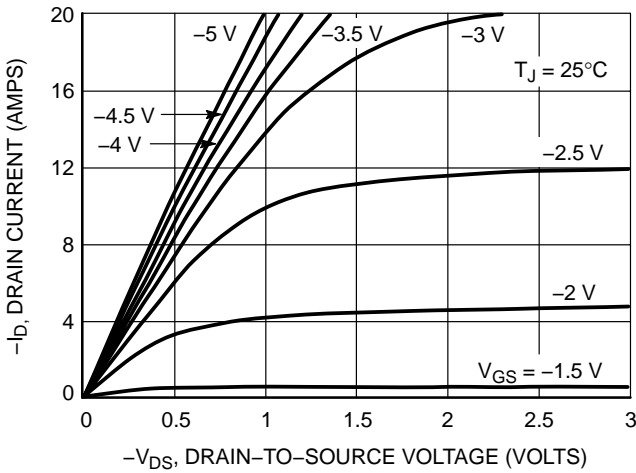

Figure 1. On-Region Characteristics

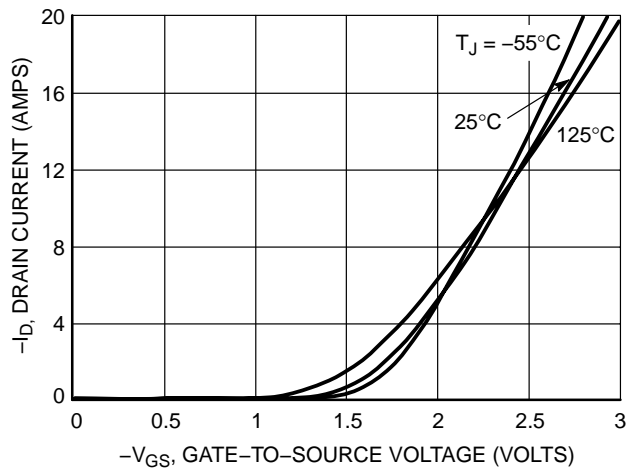

Figure 2. Transfer Characteristics

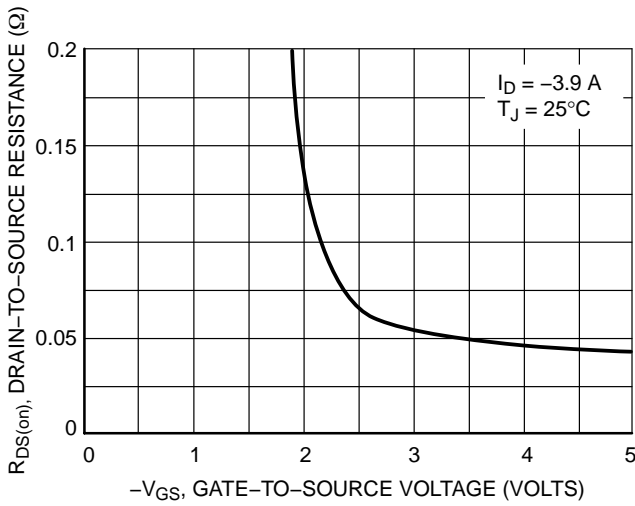

Figure 3. On-Resistance versus Gate-to-Source Voltage

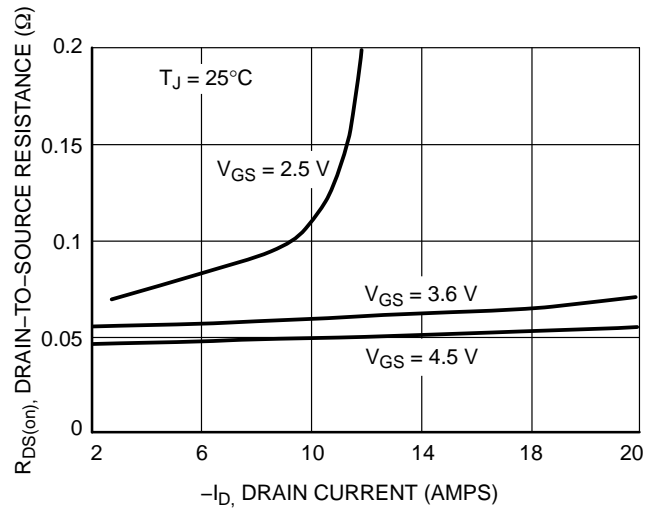

Figure 4. On-Resistance versus Drain Current and Gate Voltage

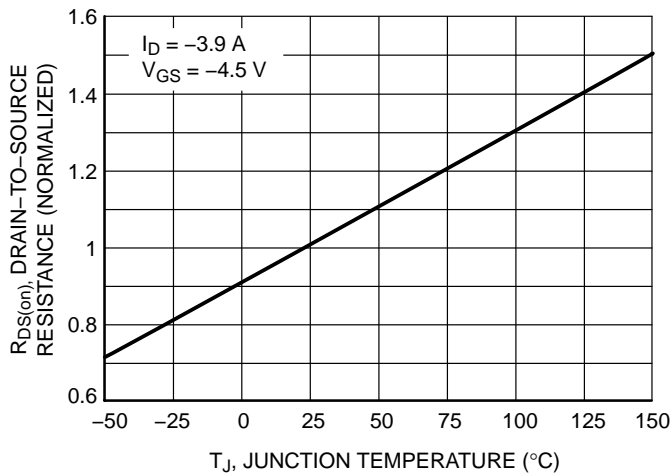

Figure 5. On-Resistance Variation with Temperature

TYPICAL ELECTRICAL CHARACTERISTICS

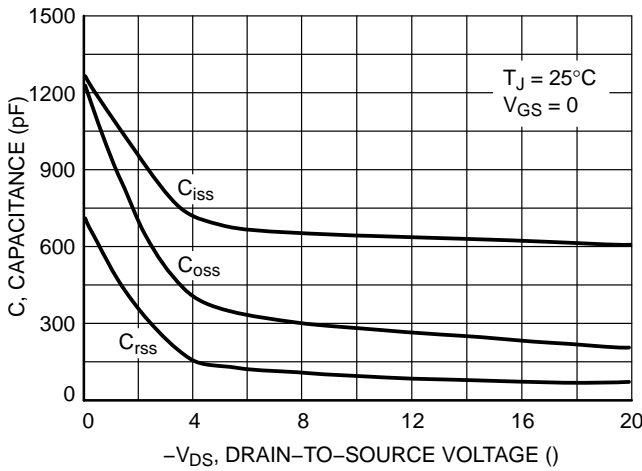

Figure 6. Capacitance Variation

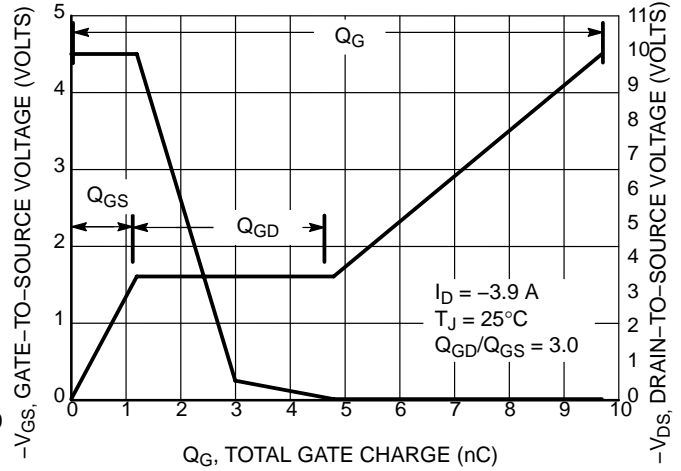

Figure 7. Gate-to-Source and Drain-to-Source Voltage versus Total Charge

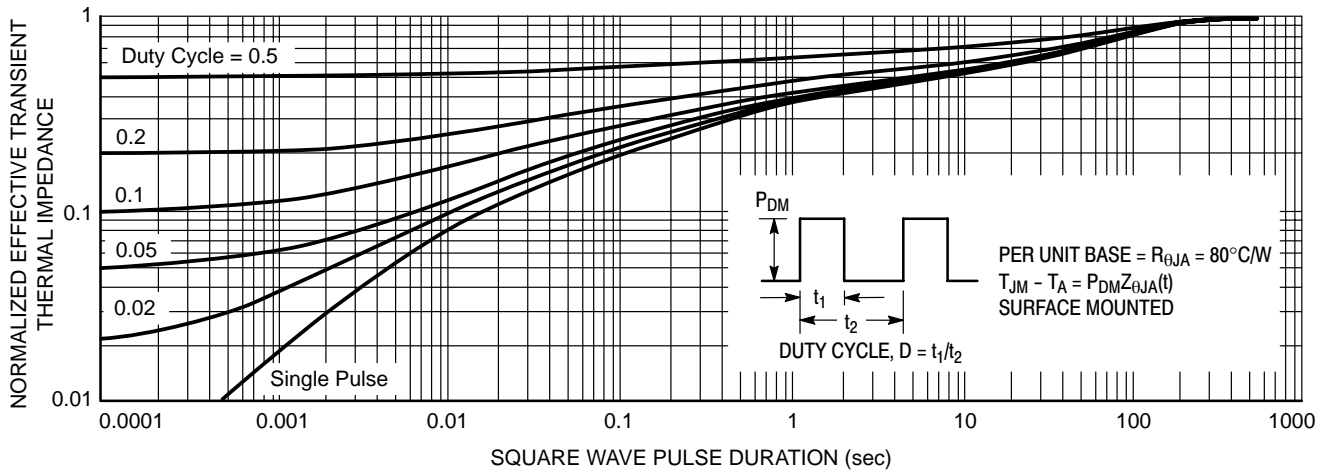

Figure 8. Normalized Thermal Transient Impedance, Junction-to-Ambient

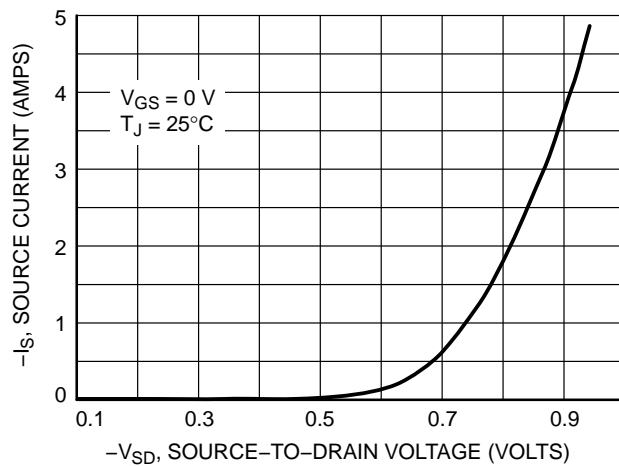
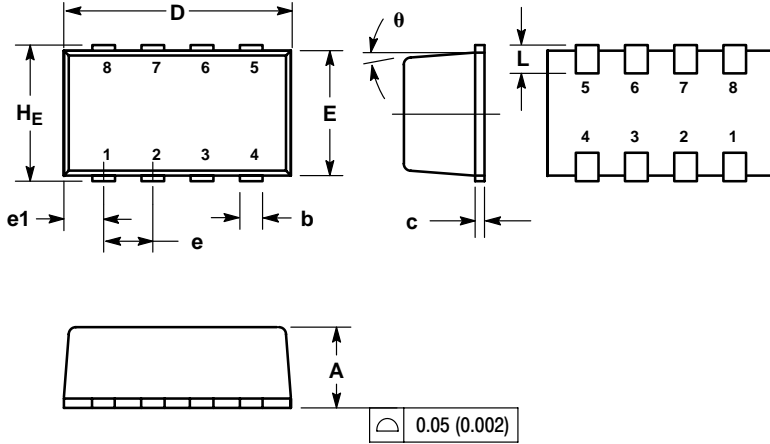

Figure 9. Diode Forward Voltage versus Current

NTHS5441

PACKAGE DIMENSIONS

ChipFET™ CASE 1206A-03 ISSUE G



NOTES:

1. DIMENSIONING AND TOLERANCING PER ANSI Y14.5M, 1982.
2. CONTROLLING DIMENSION: MILLIMETER.
3. MOLD GATE BURRS SHALL NOT EXCEED 0.13 MM PER SIDE.
4. LEADFRAME TO MOLDED BODY OFFSET IN HORIZONTAL AND VERTICAL SHALL NOT EXCEED 0.08 MM.
5. DIMENSIONS A AND B EXCLUSIVE OF MOLD GATE BURRS.
6. NO MOLD FLASH ALLOWED ON THE TOP AND BOTTOM LEAD SURFACE.

DIM	MILLIMETERS			INCHES		
	MIN	NOM	MAX	MIN	NOM	MAX
A	1.00	1.05	1.10	0.039	0.041	0.043
b	0.25	0.30	0.35	0.010	0.012	0.014
c	0.10	0.15	0.20	0.004	0.006	0.008
D	2.95	3.05	3.10	0.116	0.120	0.122
E	1.55	1.65	1.70	0.061	0.065	0.067
e	0.65 BSC			0.025 BSC		
e1	0.55 BSC			0.022 BSC		
L	0.28	0.35	0.42	0.011	0.014	0.017
HE	1.80	1.90	2.00	0.071	0.075	0.079
θ	5° NOM			5° NOM		

SOLDERING FOOTPRINT*

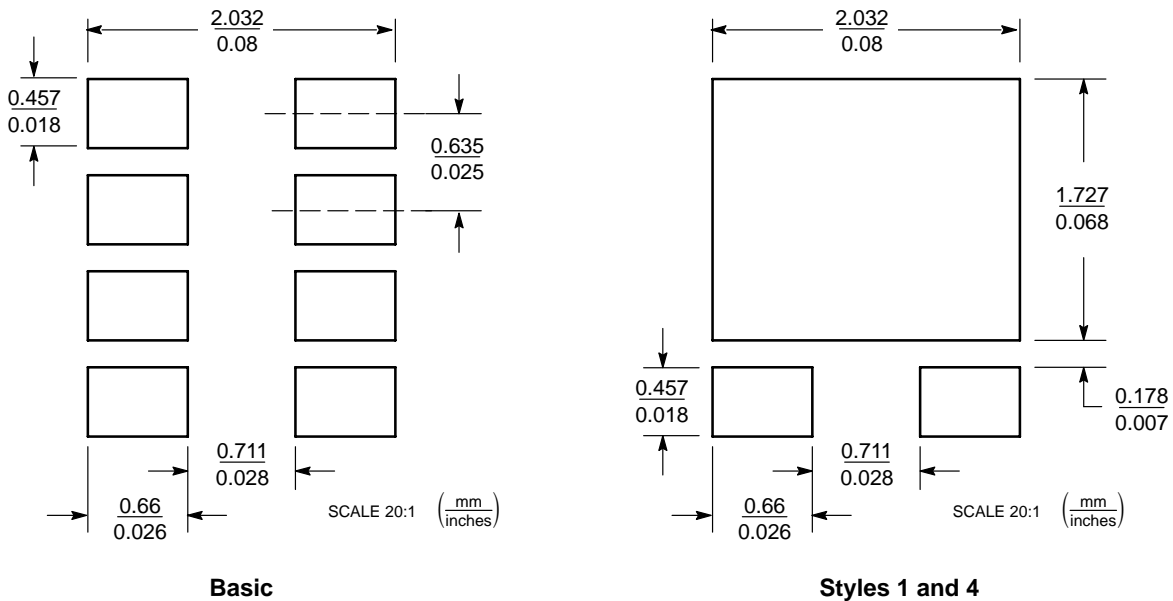

*For additional information on our Pb-Free strategy and soldering details, please download the ON Semiconductor Soldering and Mounting Techniques Reference Manual, SOLDERRM/D.

ChipFET is a trademark of Vishay Siliconix.

ON Semiconductor and  are registered trademarks of Semiconductor Components Industries, LLC (SCILLC). SCILLC reserves the right to make changes without further notice to any products herein. SCILLC makes no warranty, representation or guarantee regarding the suitability of its products for any particular purpose, nor does SCILLC assume any liability arising out of the application or use of any product or circuit, and specifically disclaims any and all liability, including without limitation special, consequential or incidental damages. "Typical" parameters which may be provided in SCILLC data sheets and/or specifications can and do vary in different applications and actual performance may vary over time. All operating parameters, including "Typicals" must be validated for each customer application by customer's technical experts. SCILLC does not convey any license under its patent rights nor the rights of others. SCILLC products are not designed, intended, or authorized for use as components in systems intended for surgical implant into the body, or other applications intended to support or sustain life, or for any other application in which the failure of the SCILLC product could create a situation where personal injury or death may occur. Should Buyer purchase or use SCILLC products for any such unintended or unauthorized application, Buyer shall indemnify and hold SCILLC and its officers, employees, subsidiaries, affiliates, and distributors harmless against all claims, costs, damages, and expenses, and reasonable attorney fees arising out of, directly or indirectly, any claim of personal injury or death associated with such unintended or unauthorized use, even if such claim alleges that SCILLC was negligent regarding the design or manufacture of the part. SCILLC is an Equal Opportunity/Affirmative Action Employer. This literature is subject to all applicable copyright laws and is not for resale in any manner.

PUBLICATION ORDERING INFORMATION

LITERATURE FULFILLMENT:

Literature Distribution Center for ON Semiconductor
P.O. Box 61312, Phoenix, Arizona 85082-1312 USA
Phone: 480-829-7710 or 800-344-3860 Toll Free USA/Canada
Fax: 480-829-7709 or 800-344-3867 Toll Free USA/Canada
Email: orderlit@onsemi.com

N. American Technical Support: 800-282-9855 Toll Free
USA/Canada

Japan: ON Semiconductor, Japan Customer Focus Center
2-9-1 Kamimeguro, Meguro-ku, Tokyo, Japan 153-0051
Phone: 81-3-5773-3850

ON Semiconductor Website: <http://onsemi.com>

Order Literature: <http://www.onsemi.com/litorder>

For additional information, please contact your
local Sales Representative.